

MOS FET Relay

**G3VM-
XN(F)/4N(F)**

**SSR for Switching Analog Signals, with
an I/O Dielectric Strength of 2.5 kVAC
Using Optical Isolation**

- Switches minute analog signals.
- Linear voltage and current characteristics.
- Switches AC and DC.
- Low ON-resistance.
- Current leakage less than 1 μ A between output terminals when they are open.
- Surface-mounting models also available.
- UL/CSA approval pending.



Ordering Information

Contact form	Terminals	Load voltage (peak value)	Model	Number per stick	Taping quantity
SPST-NO	PCB terminals	60 VAC	G3VM-XN	50	---
		400 VAC	G3VM-4N		
	Surface-mounting terminals	60 VAC	G3VM-XNF		
		400 VAC	G3VM-4NF		

Model Number Legend:

G3VM-

1 2

1. Load Voltage

- XN: A load voltage of 60 VDC or 60 VAC (peak value)
- 4N: A load voltage of 400 VDC or 400 VAC (peak value)

2. Terminal

- None: PCB terminals
- F: Surface-mounting terminals

Application Examples

- Electronic automatic exchange systems
- Measurement control systems
- Data gathering systems
- Measuring systems

Specifications

■ Absolute Maximum Ratings (Ta = 25°C)

Item			G3VM-XN(F)	G3VM-4N(F)	Conditions	
Input	LED forward current	I_F	30 mA		---	
	Repetitive peak LED forward current	I_{FP}	1 A		100- μ s pulses, 100 pps	
	LED reverse voltage	V_R	5 V		---	
Output	Output dielectric strength (load voltage)	V_{BO}	-60 to 60 V	-400 to 400 V	DC or AC peak value	
			0 to 60 V	0 to 400 V	DC	
	Continuous load current (see note 1)	I_O	A connection	300 mA	150 mA	---
			B connection	450 mA	200 mA	
C connection			600 mA	300 mA		
Dielectric strength between I/O terminals (see note 2)		V_{I-O}	2,500 V AC		1 min	
Ambient temperature		Ta	-20 to 85°C		With no icing or condensation	
Storage temperature		Tstg	-55 to 100°C		With no icing or condensation	
Max. soldering temperature and time		---	260°C		10 s	

Note: 1. The load current attenuation rates for the different types of connection are as follows:

G3VM-XN(F): A: -3.0 mA/°C; B: -4.5 mA/°C; C: -6.0 mA/°C

G3VM-4N(F): A: -1.5 mA/°C; B: -2.0 mA/°C; C: -3.0 mA/°C

2. The dielectric strength between I/O terminals was measured with voltage applied to all of the LED pins and with voltage applied to all of the light-receiving parts respectively.

Connection Circuit Diagram

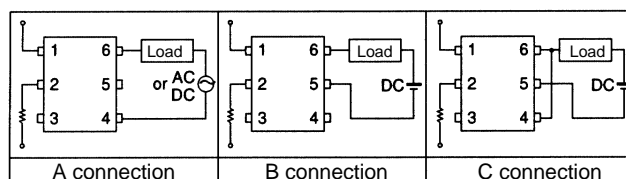

■ Electrical Performance (Ta = 25°C)

Item			G3VM-XN(F)	G3VM-4N(F)	Unit	Conditions
Input	LED forward current	V_F	1.2 V min, 1.7 V max.		V	$I_F = 10$ mA
	Trigger LED forward current	I_{FT}	5 mA max.			$I_O = 300$ mA (G3VM-XN(F)) $I_O = 150$ mA (G3VM-4N(F))
Output	Output ON resistance	A connection	R_{ON}	2 Ω max.	12 Ω max.	$I_F = 10$ mA $I_O = \text{MAX}$
		B connection		1 Ω max.	6 Ω max.	
		C connection		0.5 Ω max.	3 Ω max.	
	Switching current leakage	I_{LEAK}	1.0 μ A max.		μ A	$V_{off} = 60$ V (G3VM-XN(F)) $V_{off} = 400$ V (G3VM-4N(F))
Operate time		T_{ON}	0.5 ms max.	1.0 ms max.	ms	$R_L = 200$ Ω (see note)
Release time		T_{OFF}	0.5 ms max.	1.0 ms max.	ms	$V_{DD} = 20$ V, $I_F = 10$ mA
Floating capacity between I/O terminals		C_{I-O}	0.8 pF, TYP		pF	f = 1 MHz

Note: The operate and release time were measured in the way shown below.

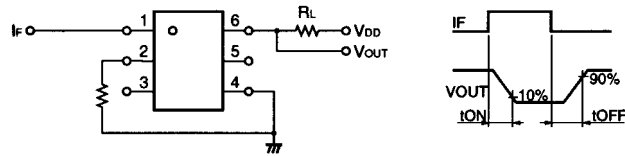

Dimensions

Note: All units are in millimeters unless otherwise indicated.

**G3VM-XN
G3VM-4N**

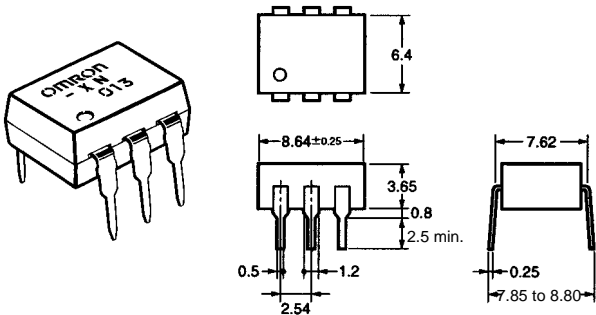

**G3VM-XNF
G3VM-4NF**

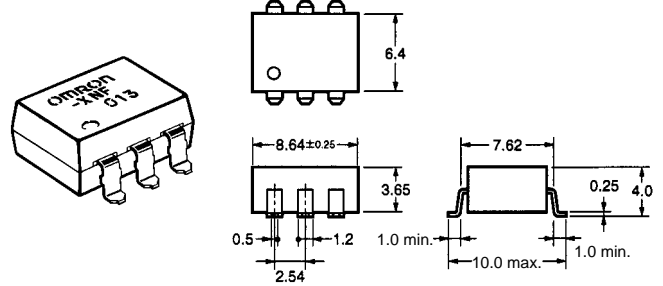

Note: "G3VM" is not printed on the actual product.

■ PCB Dimensions (Bottom View)

**G3VM-XN
G3VM-4N**

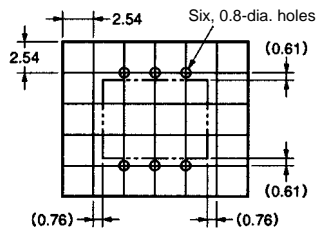

■ Actual Mounting Pad Dimensions (Recommended Value, Top View)

**G3VM-XNF
G3VM-4NF**

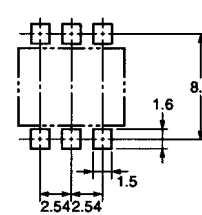

Note: Mounting pad dimensions shown are a top view.

Installation

■ Terminal Arrangement/Internal Connection (Top View)

**G3VM-XN
G3VM-4N**

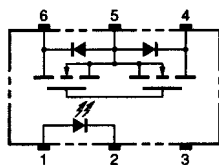

**G3VM-XNF
G3VM-4NF**

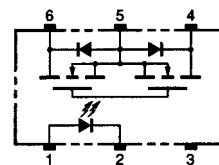

Precautions

! WARNING

Be sure to turn OFF the power when wiring the Relay, otherwise an electric shock may be received.

! WARNING

Do not touch the charged terminals of the SSR, otherwise an electric shock may be received.

! Caution

Do not apply overvoltage or overcurrent to the I/O circuits of the SSR, otherwise the SSR may malfunction or burn.

! Caution

Be sure to wire and solder the Relay under the proper soldering conditions, otherwise the Relay in operation may generate excessive heat and the Relay may burn.

Typical Relay Driving Circuit Examples

C-MOS

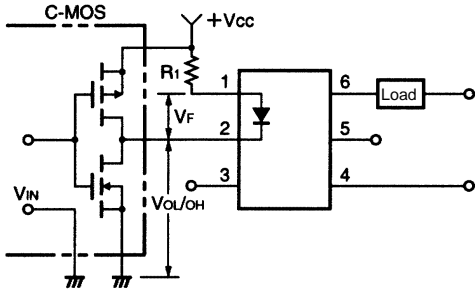

Transistor

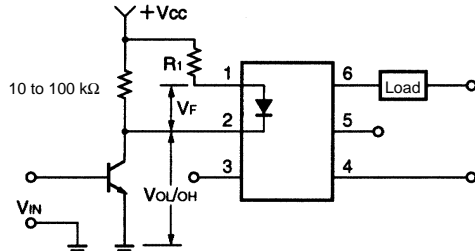

Use the following formula to obtain the LED current limiting resistance value to assure that the relay operates accurately.

$$R_1 = \frac{V_{CC} - V_{OL} - V_F(ON)}{5 \text{ to } 20 \text{ mA}}$$

Use the following formula to obtain the LED forward voltage value to assure that the relay releases accurately.

$$V_F(OFF) = V_{CC} - V_{OH} < 0.8 \text{ V}$$

Protection from Surge Voltage on the Input Terminals

If any reversed surge voltage is imposed on the input terminals, insert a diode in parallel to the input terminals as shown in the following circuit diagram and do not impose a reversed voltage value of 3 V or more.

Surge Voltage Protection Circuit Example

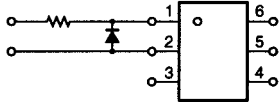

Protection from Spike Voltage on the Output Terminals

If a spike voltage exceeding the absolute maximum rated value is generated between the output terminals, insert a C-R snubber or clamping diode in parallel to the load as shown in the following circuit diagram to limit the spike voltage.

Spike Voltage Protection Circuit Example

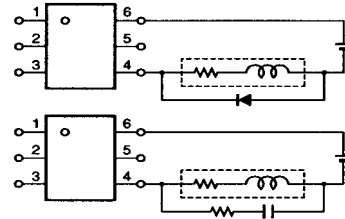

Unused Terminals (6-pin only)

Terminal 3 is connected to the internal circuit. Do not connect anything to terminal 3 externally.

Pin Strength for Automatic Mounting

In order to maintain the characteristics of the relay, the force imposed on any pin of the relay for automatic mounting must not exceed the following.

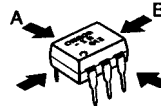

In direction A: 1.96 N
In direction B: 1.96 N

Load Connection

Do not short-circuit the input and output terminals while the relay is operating or the relay may malfunction.

AC Connection

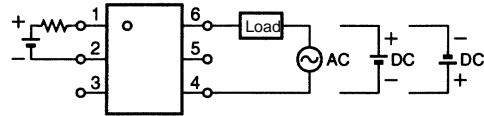

DC Single Connection

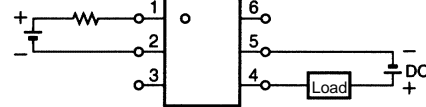
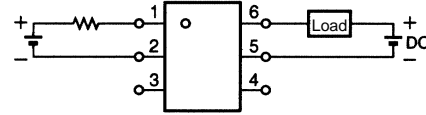

DC Parallel Connection

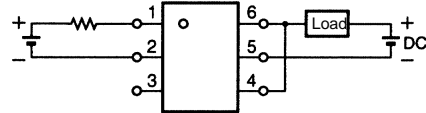

Solder Mounting

Maintain the following conditions during manual or reflow soldering of the relays in order to prevent the temperature of the relays from rising.

1. Pin Soldering
Solder each pin at a maximum temperature of 260°C within 10 s.
2. Reflow Soldering
 - a. Solder each pin at a maximum temperature of 260°C within 10 s.
 - b. Make sure that the ambient temperature on the surface of the resin casing is 240°C max. for 10 s maximum.
 - c. The following temperature changes are recommendable for soldering.

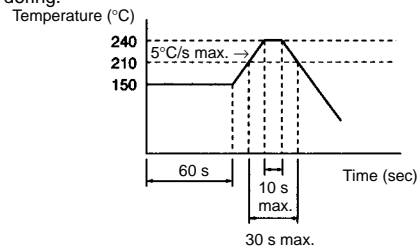

ALL DIMENSIONS SHOWN ARE IN MILLIMETERS.

To convert millimeters into inches, multiply by 0.03937. To convert grams into ounces, multiply by 0.03527.

Cat. No. K112-E1-1 **In the interest of product improvement, specifications are subject to change without notice.**

OMRON Corporation

Electronic & Mechanical Components Division H.Q.
Low Signal Relay Division
28th Fl., Crystal Tower Bldg.,
1-2-27, Shiromi, Chuo-ku,
Osaka 540-6028 Japan
Tel: (81)6-6949-6115/Fax: (81)6-6949-6114

Printed in Japan
0500-3M (0500) (O)