

## MOS FET Relay

**G3VM-6(F)**

**New Model with Dielectric Strength of 400 V and 5,000 V between Input and Output Terminals**

- UL1577 (File No. E67349) pending approval.
- EN60065 (Recognition No. 8318) pending approval.
- EN60950 (Recognition No. 8319) pending approval.
- VDE0884 (Recognition No. 9850781) pending approval.



## Ordering Information

### ■ Appearance

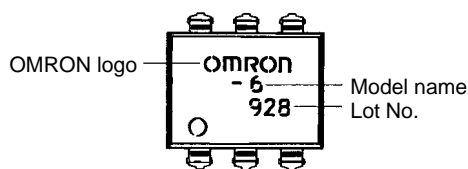

**Note:** "G3VM" is not printed on the actual product.

Contact form	Terminals	Load voltage (peak value)	Model	Number per stick
SPST-NO	PCB terminals	400 VAC (DC or AC)	G3VM-6	50
	Surface-mounting terminals		G3VM-6F	50

**Note:** Only available on stick.

## Application Examples

- Electronic automatic exchange systems
- Gauging control systems
- Data management systems
- Gauging systems

# Specifications

## ■ Absolute Maximum Ratings (Ta = 25°C)

Item		Symbol	Ratings	Unit	
Input	LED forward current	$I_F$	30	mA	
	Repetitive peak LED forward current (Duty: 1% max.; pulse width: 100 $\mu$ s max.)	$I_{FP}$	1	A	
	LED reverse voltage	$V_R$	5	V	
Output	Output dielectric strength (see note 2)	Connection A	$V_{BO}$	DC or AC peak value: -400 to 400	V
		Connection B	$V_{BO}$	DC: 0 to 400	V
		Connection C			
	Continuous load current (see note 1)	Connection A	$I_O$	150	mA
Connection B		200			
Connection C		300			
Dielectric strength between I/O terminals (AC for 1 min, operating ambient humidity $\leq$ 60%) (see note 2)		$V_{I-O}$	5,000	Vrms	
Ambient temperature (with no icing or condensation)		Ta	-40 to +85	°C	
Storage temperature (with no icing or condensation)		Tstg	-55 to +125	°C	
Soldering temperature (10 s)		---	260	°C	

**Note:** 1. The output load current varies depending on the ambient temperature. Refer to *Engineering Data*.

2. The dielectric strength was checked for each connection by applying a voltage between each pairing of pins 1, 2, and 3 and pins 4, 5, and 6.

Connection diagram

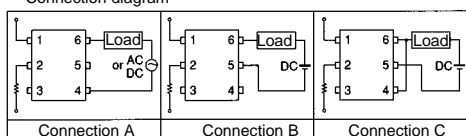

## ■ Electrical Characteristics (Ta = 25°C)

Item		Symbol	Minimum	Typical	Maximum	Unit	Measurement conditions
Output ON resistance	Connection A	$R_{ON}$	---	---	12	$\Omega$	$I_F=10$ mA, $I_{ON}=100$ mA
	Connection B		---	---	6		
	Connection C		---	---	3		
Current leakage when the relay is closed		$I_{LEAK}$	---	---	1.0	$\mu$ A	$V_{ON}=V_{BO}$
LED forward voltage		$V_F$	1.2	1.4	1.7	V	$I_F=10$ mA
Capacity between I/O terminals		$C_{I-O}$	---	0.8	---	pF	f=1 MHz
Insulation resistance between I/O terminals		$R_{I-O}$	$5 \times 10^{10}$	---	---	$\Omega$	$V_F=0$ , $V_0=0$ , $V_{I-O}=500$ VDC
Operating time		$T_{ON}$	---	---	1	ms	$I_F=10$ mA, $V_{DD}=20$ V, $R_L=200$ $\Omega$ (see note)
Release time		$T_{OFF}$	---	---	1	ms	$I_F=10$ mA, $V_{DD}=20$ V, $R_L=200$ $\Omega$ (see note)

**Note:** Switching Time Measuring Circuit

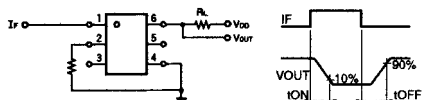

■ Recommended Operating Conditions

Item	Symbol	Minimum	Typical	Maximum	Unit
Operating voltage	$V_{DD}$	---	---	320	V
Forward current	$I_F$	10	15	20	mA
ON current	$I_{ON}$	---	---	150	mA
Operating temperature	$T_{opr}$	-20	---	80	°C

Engineering Data

■ Reference Data

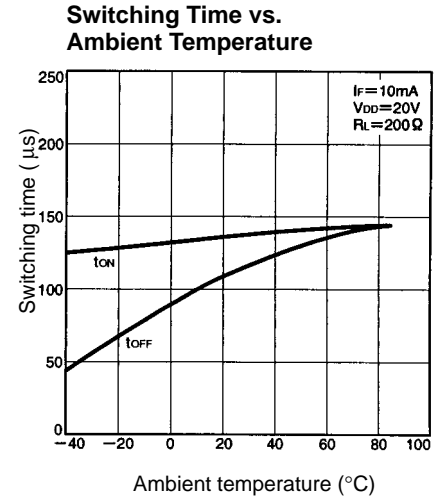
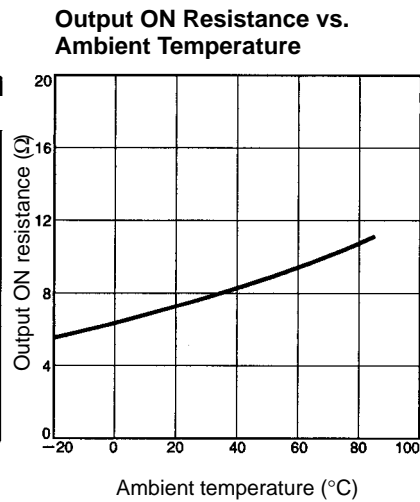
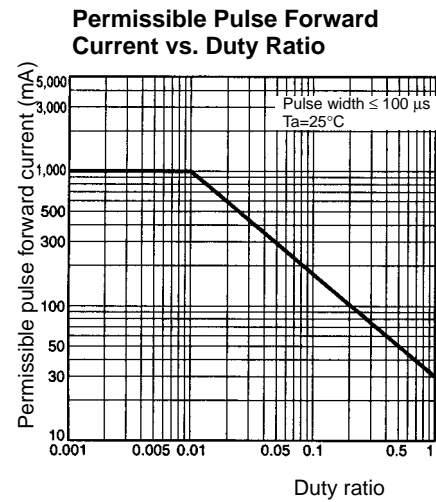
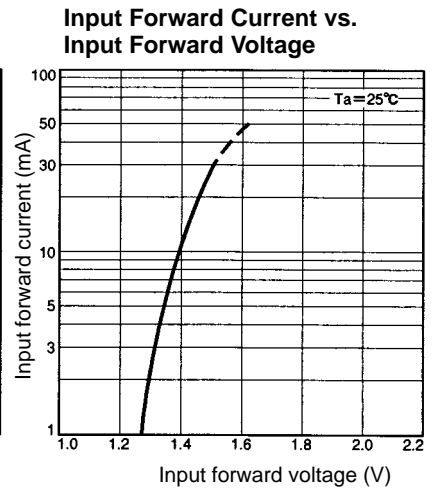
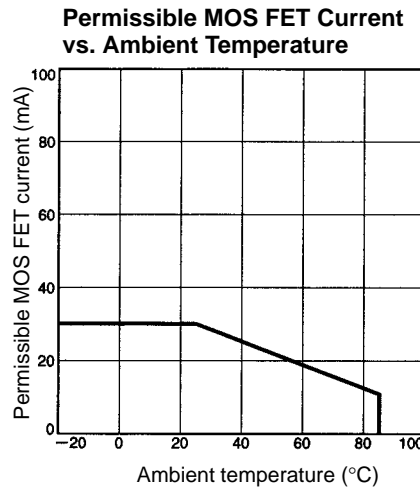
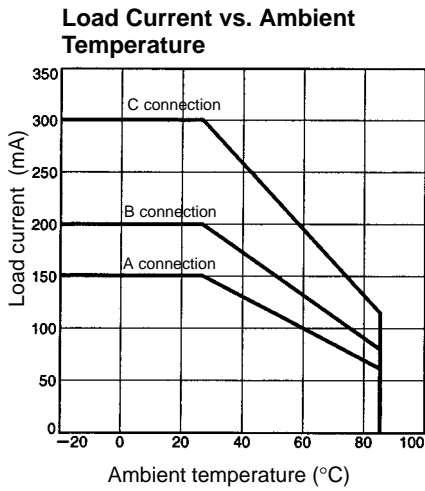

# Dimensions

**Note:** All units are in millimeters unless otherwise indicated.

## G3VM-6

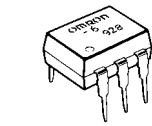

Unit: mm  
Weight: 0.49 g

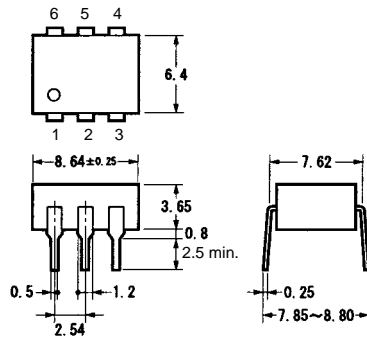

**Terminal Arrangement/ Internal Connections (Top View)**

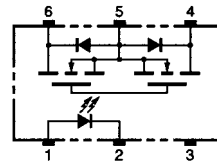

**Actual Mounting Pad Dimensions (Recommended Value, Top View)**

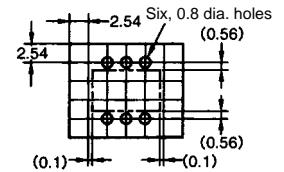

**Note:** "G3VM" is not printed on the actual product.

## G3VM-6F

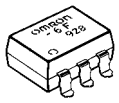

Unit: mm  
Weight: 0.49 g

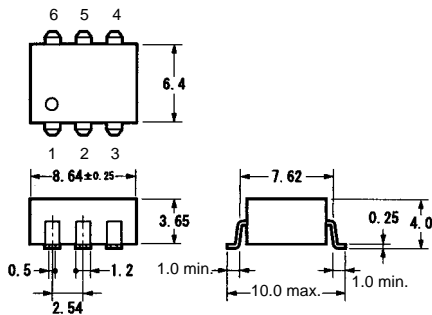

**Terminal Arrangement/ Internal Connections (Top View)**

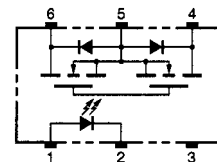

**Actual Mounting Pad Dimensions (Recommended Value, Top View)**

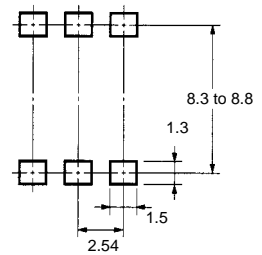

**Note:** "G3VM" is not printed on the actual product.

# Precautions

## ■ Correct Use

### Recommended Operating Conditions

Use the G3VM under the following conditions so that the Relay will operate properly.

Item	Min.	Type	Max.
Operating LED forward current	---	1 mA	5 mA
Releasing LED forward voltage	0.1 V	0.5 V	---